

The RF Sub-Micron MOSFET Line
RF Power Field Effect Transistors
N-Channel Enhancement-Mode Lateral MOSFETs

MRF284
MRF284S

30 W, 2000 MHz, 26 V
LATERAL N-CHANNEL
BROADBAND
RF POWER MOSFETS

Designed for PCN and PCS base station applications at frequencies from 1000 to 2600 MHz. Suitable for FM, TDMA, CDMA, and multicarrier amplifier applications. To be used in class A and class AB for PCN-PCS/cellular radio and wireless local loop.

- Specified Two-Tone Performance @ 2000 MHz, 26 Volts
Output Power = 30 Watts (PEP)
Power Gain = 9 dB
Efficiency = 30%
Intermodulation Distortion = -29 dBc
- Typical Single-Tone Performance at 2000 MHz, 26 Volts
Output Power = 30 Watts (CW)
Power Gain = 9.5 dB
Efficiency = 45%
- Characterized with Series Equivalent Large-Signal Impedance Parameters
- S-Parameter Characterization at High Bias Levels
- Excellent Thermal Stability
- Capable of Handling 10:1 VSWR, @ 26 Vdc, 2000 MHz, 30 Watts (CW)
Output Power

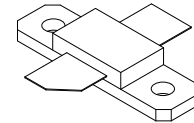

CASE 360B-01, STYLE 1
(MRF284)

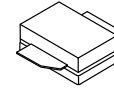

CASE 360C-03, STYLE 1
(MRF284S)

MAXIMUM RATINGS

Rating	Symbol	Value	Unit
Drain-Source Voltage	V _{DSS}	65	Vdc
Gate-Source Voltage	V _{GS}	±20	Vdc
Total Device Dissipation @ T _C = 25°C Derate above 25°C	P _D	87.5 0.5	Watts W/°C
Storage Temperature Range	T _{stg}	-65 to +150	°C
Operating Junction Temperature	T _J	200	°C

THERMAL CHARACTERISTICS

Characteristic	Symbol	Max	Unit
Thermal Resistance, Junction to Case	R _{θJC}	2.0	°C/W

ELECTRICAL CHARACTERISTICS (T_C = 25°C unless otherwise noted)

Characteristic	Symbol	Min	Typ	Max	Unit
----------------	--------	-----	-----	-----	------

OFF CHARACTERISTICS

Drain-Source Breakdown Voltage (V _{GS} = 0, I _D = 10 μAdc)	V _{(BR)DSS}	65	—	—	Vdc
Zero Gate Voltage Drain Current (V _{DS} = 20 Vdc, V _{GS} = 0)	I _{DSS}	—	—	1.0	μAdc
Gate-Source Leakage Current (V _{GS} = 20 Vdc, V _{DS} = 0)	I _{GSS}	—	—	10	μAdc

NOTE - **CAUTION** - MOS devices are susceptible to damage from electrostatic charge. Reasonable precautions in handling and packaging MOS devices should be observed.

ELECTRICAL CHARACTERISTICS ($T_C = 25^\circ\text{C}$ unless otherwise noted)

Characteristic	Symbol	Min	Typ	Max	Unit
ON CHARACTERISTICS					
Gate Threshold Voltage ($V_{DS} = 10\text{ Vdc}$, $I_D = 150\ \mu\text{Adc}$)	$V_{GS(th)}$	2.0	3.0	4.0	Vdc
Gate Quiescent Voltage ($V_{DS} = 26\text{ Vdc}$, $I_D = 200\ \text{mAdc}$)	$V_{GS(q)}$	3.0	4.0	5.0	Vdc
Drain–Source On–Voltage ($V_{GS} = 10\text{ Vdc}$, $I_D = 1.0\ \text{Adc}$)	$V_{DS(on)}$	—	0.3	0.6	Vdc
Forward Transconductance ($V_{DS} = 10\text{ Vdc}$, $I_D = 1.0\ \text{Adc}$)	g_{fs}	1.0	1.5	—	S
DYNAMIC CHARACTERISTICS					
Input Capacitance ($V_{DS} = 26\text{ Vdc}$, $V_{GS} = 0$, $f = 1.0\ \text{MHz}$)	C_{iss}	—	43	—	pF
Output Capacitance ($V_{DS} = 26\text{ Vdc}$, $V_{GS} = 0$, $f = 1.0\ \text{MHz}$)	C_{oss}	—	23	—	pF
Reverse Transfer Capacitance ($V_{DS} = 26\text{ Vdc}$, $V_{GS} = 0$, $f = 1.0\ \text{MHz}$)	C_{rss}	—	1.4	—	pF
FUNCTIONAL TESTS (in Motorola Test Fixture)					
Common–Source Power Gain ($V_{DD} = 26\text{ Vdc}$, $P_{out} = 30\ \text{W}$, $I_{DQ} = 200\ \text{mA}$, $f_1 = 2000.0\ \text{MHz}$, $f_2 = 2000.1\ \text{MHz}$)	G_{ps}	9	10.5	—	dB
Drain Efficiency ($V_{DD} = 26\text{ Vdc}$, $P_{out} = 30\ \text{W}$, $I_{DQ} = 200\ \text{mA}$, $f_1 = 2000.0\ \text{MHz}$, $f_2 = 2000.1\ \text{MHz}$)	η	30	35	—	%
Intermodulation Distortion ($V_{DD} = 26\text{ Vdc}$, $P_{out} = 30\ \text{W}$, $I_{DQ} = 200\ \text{mA}$, $f_1 = 2000.0\ \text{MHz}$, $f_2 = 2000.1\ \text{MHz}$)	IMD	—	–32	–29	dBc
Input Return Loss ($V_{DD} = 26\text{ Vdc}$, $P_{out} = 30\ \text{W}$, $I_{DQ} = 200\ \text{mA}$, $f_1 = 2000.0\ \text{MHz}$, $f_2 = 2000.1\ \text{MHz}$)	IRL	9	15	—	dB
Common–Source Amplifier Power Gain ($V_{DD} = 26\text{ Vdc}$, $P_{out} = 30\ \text{W PEP}$, $I_{DQ} = 200\ \text{mA}$, $f_1 = 1930.0\ \text{MHz}$, $f_2 = 1930.1\ \text{MHz}$)	G_{ps}	9	10.4	—	dB
Drain Efficiency ($V_{DD} = 26\text{ Vdc}$, $P_{out} = 30\ \text{W PEP}$, $I_{DQ} = 200\ \text{mA}$, $f_1 = 1930.0\ \text{MHz}$, $f_2 = 1930.1\ \text{MHz}$)	η	—	35	—	%
Intermodulation Distortion ($V_{DD} = 26\text{ Vdc}$, $P_{out} = 30\ \text{W PEP}$, $I_{DQ} = 200\ \text{mA}$, $f_1 = 1930.0\ \text{MHz}$, $f_2 = 1930.1\ \text{MHz}$)	IMD	—	–34	—	dBc
Input Return Loss ($V_{DD} = 26\text{ Vdc}$, $P_{out} = 30\ \text{W PEP}$, $I_{DQ} = 200\ \text{mA}$, $f_1 = 1930.0\ \text{MHz}$, $f_2 = 1930.1\ \text{MHz}$)	IRL	9	15	—	dB
Common–Source Amplifier Power Gain ($V_{DD} = 26\text{ Vdc}$, $P_{out} = 30\ \text{W CW}$, $I_{DQ} = 200\ \text{mA}$, $f_1 = 2000.0\ \text{MHz}$)	G_{ps}	8.5	9.5	—	dB
Drain Efficiency ($V_{DD} = 26\text{ Vdc}$, $P_{out} = 30\ \text{W CW}$, $I_{DQ} = 200\ \text{mA}$, $f_1 = 2000.0\ \text{MHz}$)	η	35	45	—	%
Output Mismatch Stress ($V_{DD} = 26\text{ Vdc}$, $P_{out} = 30\ \text{W CW}$, $I_{DQ} = 200\ \text{mA}$, $f_1 = 2000.0\ \text{MHz}$, $V_{SWR} = 10:1$, at All Phase Angles)	Ψ	No Degradation In Output Power			

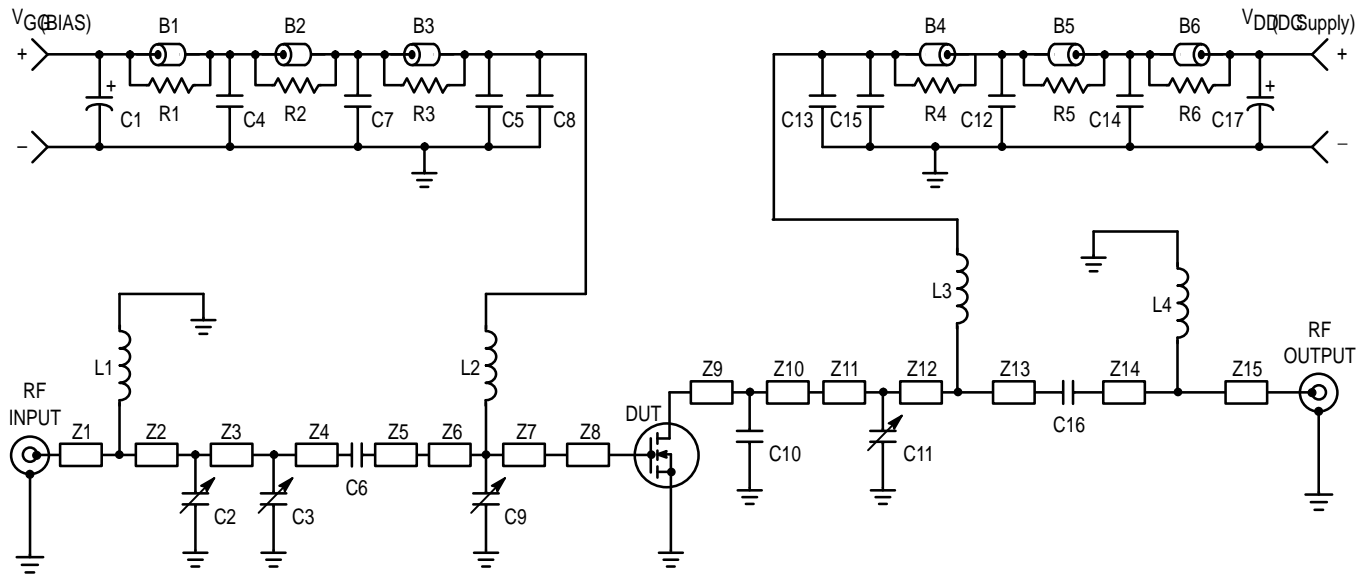

B1 – B6	Ferrite Bead, Round	Z3	0.185" x 0.080" Microstrip
C1, C17	470 μ F, 63 V, Mallory Electrolytic Capacitor	Z4	0.395" x 0.080" Microstrip
C2	0.6 – 4.5 pF Johansen Gigatrim Variable Capacitors	Z5	0.490" x 0.080" Microstrip
C3, C9	0.8 – 8.0 pF Johansen Gigatrim Variable Capacitors	Z6	0.035" x 0.325" Microstrip
C4, C14	0.1 μ F Chip Capacitor, KEMET	Z7	0.240" x 0.325" Microstrip
C5, C15	91 pF ATC RF Chip Capacitors, Case "B"	Z8	0.210" x 0.515" Microstrip
C6, C16	10 pF ATC RF Chip Capacitors, Case "B"	Z9	0.130" x 0.515" Microstrip
C7, C12	1000 pF ATC RF Chip Capacitors, Case "B"	Z10	0.080" x 0.515" Microstrip
C8, C13	5.1 pF ATC RF Chip Capacitors, Case "B"	Z11	0.190" x 0.325" Microstrip
C10	2.7 pF ATC RF Chip Capacitors, Case "B"	Z12	0.090" x 0.325" Microstrip
C11	0.4 – 2.5 pF Johansen Gigatrim Variable Capacitors	Z13	0.515" x 0.080" Microstrip
L1	4 Turns, #27 AWG, 0.087" OD, 0.050" ID, 0.069" Long, 10 nH	Z14	0.860" x 0.080" Microstrip
L2, L3	9 Turns, #26 AWG, 0.080" OD, 0.046" ID, 0.170" Long, 30.8 nH	Z15	0.510" x 0.080" Microstrip
L4	2 Turns, #24 AWG, 0.85" OD, 0.042" ID, 0.064" Long, 5.2 nH	Board	0.030" Glass Teflon, 2 oz Copper, 3 x 5" Dimensions, Manufacturer; Arlon, P/N: GX0300–55–22, $\epsilon_r = 2.55$
R1 – R6	12 Ω Fixed Film Chip Resistor 0.08" x 0.13"		
Z1	0.145" x 0.080" Microstrip		
Z2	0.680" x 0.080" Microstrip		

Figure 1. Schematic of 1.93–2.0 GHz Broadband Test Circuit

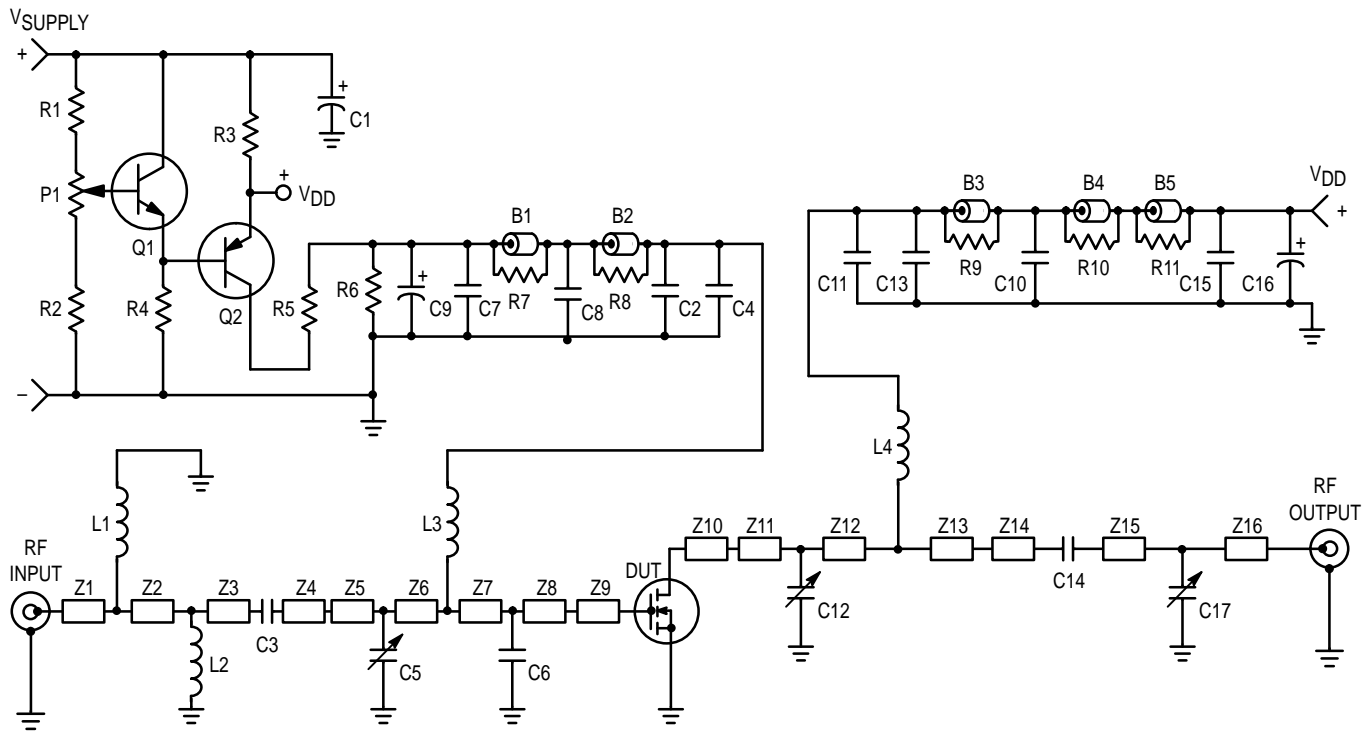

B1 – B5	Ferrite Bead, Round	R5	2 x 1500 Ω , Fixed Film Chip Resistor 0.08" x 0.13"
C1, C9, C16	100 μ F, 50 V, Electrolytic Capacitor, Sprague	R6	270 Ω , Fixed Film Chip Resistor, 0.08" x 0.13"
C2, C13	51 pF, ATC RF Chip Capacitors, Case "B"	R7 – R11	12 Ω , Fixed Film Chip Resistor, 0.08" x 0.13"
C3, C14	10 pF, ATC RF Chip Capacitors, Case "B"	Z1	0.363" x 0.080" Microstrip
C4, C11	12 pF, ATC RF Chip Capacitors, Case "B"	Z2	0.080" x 0.080" Microstrip
C5	0.8 – 8.0 pF Variable Capacitor, Johansen Gigatrim	Z3	0.916" x 0.080" Microstrip
C6	4.7 pF, ATC RF Chip Capacitor, Case "B"	Z4	0.517" x 0.080" Microstrip
C7, C15	91 pF, ATC RF Chip Capacitors, Case "B"	Z5	0.050" x 0.325" Microstrip
C8	1000 pF, ATC RF Chip Capacitor, Case "B"	Z6	0.050" x 0.325" Microstrip
C10	0.1 μ F, Chip Capacitor, KEMET	Z7	0.071" x 0.325" Microstrip
C12, C17	0.6 – 4.5 pF, Variable Capacitors, Johansen Gigatrim	Z8	0.125" x 0.325" Microstrip
L1	4 Turns, #27 AWG, 0.087" OD, 0.050" ID, 0.069" Long, 10 nH	Z9	0.210" x 0.515" Microstrip
L2	5 Turns, #24 AWG, 0.083" OD, 0.040" ID, 0.128" Long, 12.5 nH	Z10	0.210" x 0.515" Microstrip
L3, L4	9 Turns, #26 AWG, 0.080" OD, 0.046" ID, 0.170" Long, 30.8 nH	Z11	0.235" x 0.325" Microstrip
P1	1000 Ohm Potentiometer, 1/2 W, 10 Turns	Z12	0.02" x 0.325" Microstrip
Q1	Transistor, NPN, Motorola P/N: MJD31, Case 369A–10	Z13	0.02" x 0.325" Microstrip
Q2	Transistor, PNP, Motorola P/N: MJD32, Case 369A–10	Z14	0.510" x 0.080" Microstrip
R1	360 Ω , Fixed Film Chip Resistor 0.08" x 0.13"	Z15	0.990" x 0.080" Microstrip
R2	2 x 12 k Ω , Fixed Film Chip Resistor 0.08" x 0.13"	Z16	0.390" x 0.080" Microstrip
R3	1 Ω , Wirewound, 5 W, 3% Resistor	Raw PCB	
R4	4 x 6.8 k Ω , Fixed Film Chip Resistor 0.08" x 0.13"	Material	0.030" Glass Teflon, 2 oz Copper, 3 x 5" Dimensions, Manufacturer; Arlon, P/N: GX–0300–55–22, $\epsilon_r = 2.55$

Figure 2. Schematic of 2.0 GHz Class A Test Circuit

TYPICAL CHARACTERISTICS

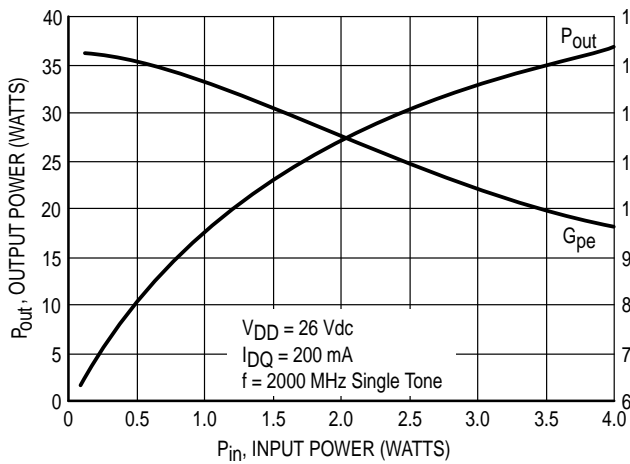

Figure 3. Output Power & Power Gain versus Input Power

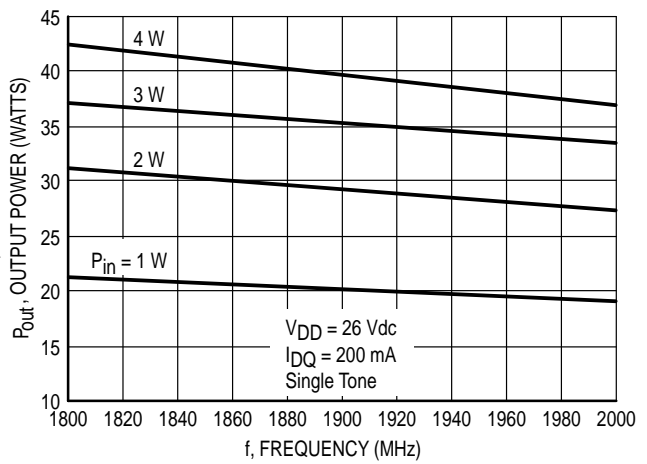

Figure 4. Output Power versus Frequency

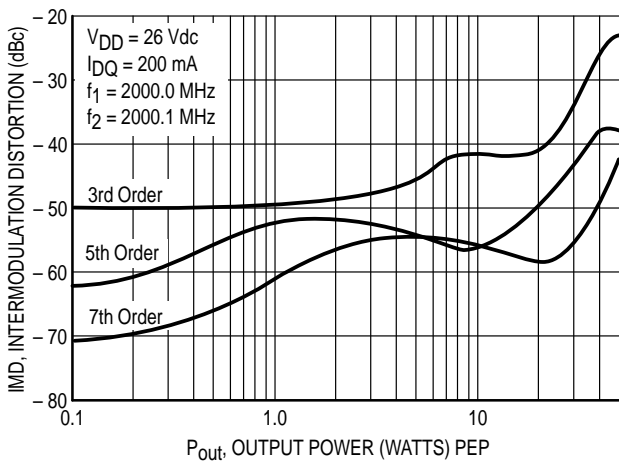

Figure 5. Intermodulation Distortion versus Output Power

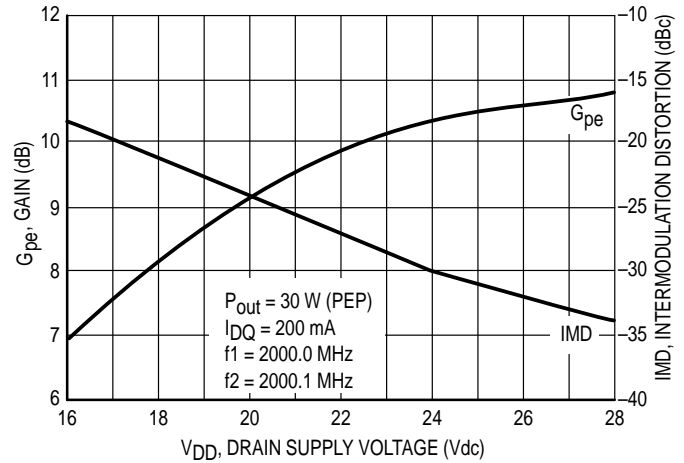

Figure 6. Power Gain and Intermodulation Distortion versus Supply Voltage

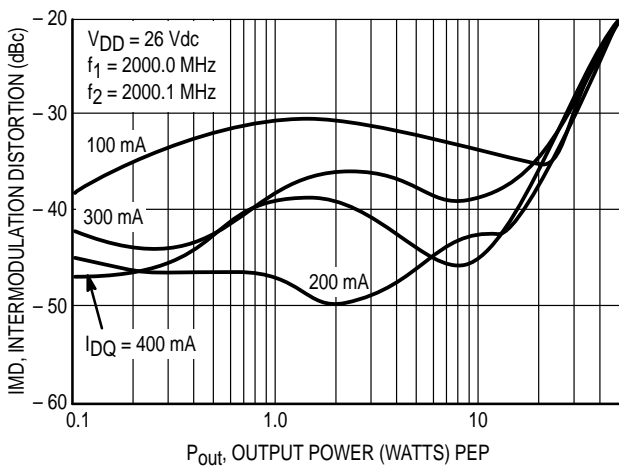

Figure 7. Intermodulation Distortion versus Output Power

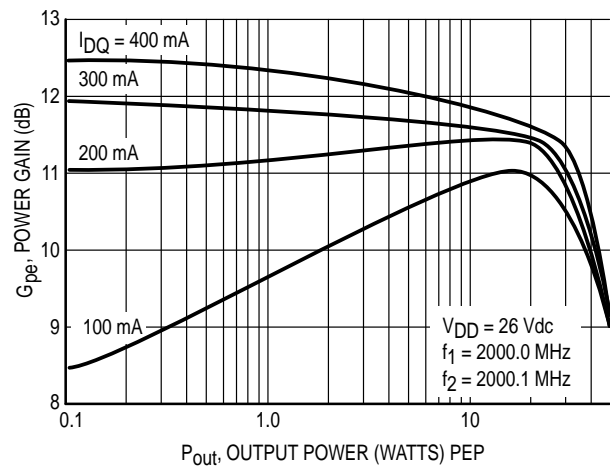

Figure 8. Power Gain versus Output Power

TYPICAL CHARACTERISTICS

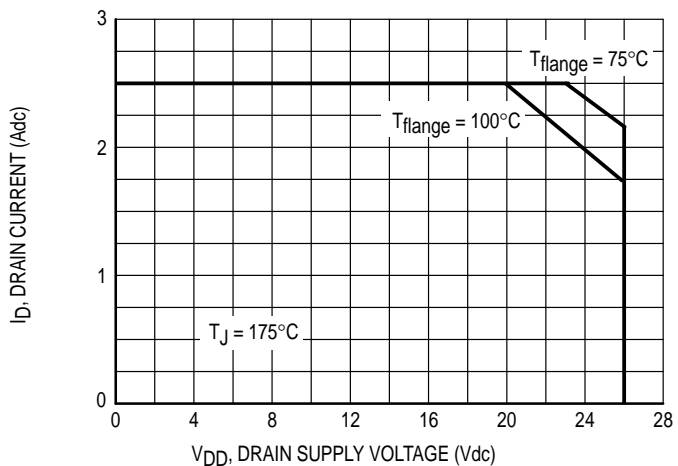

Figure 9. DC Safe Operating Area

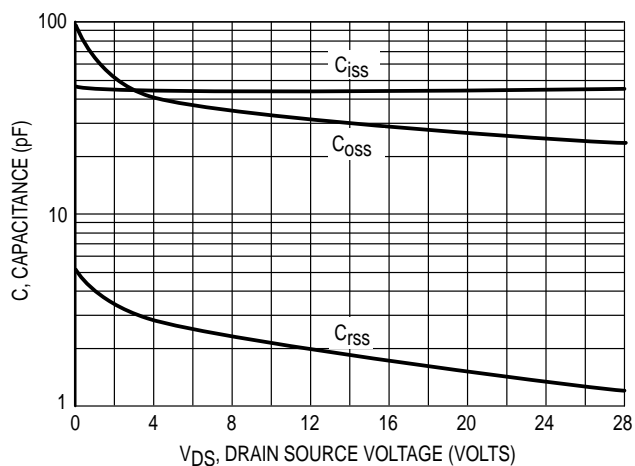

Figure 10. Capacitance versus Drain Source Voltage

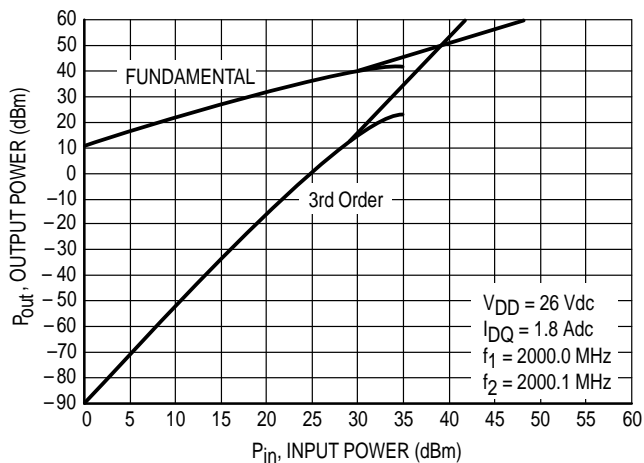

Figure 11. Class A Third Order Intercept Point

TYPICAL CHARACTERISTICS

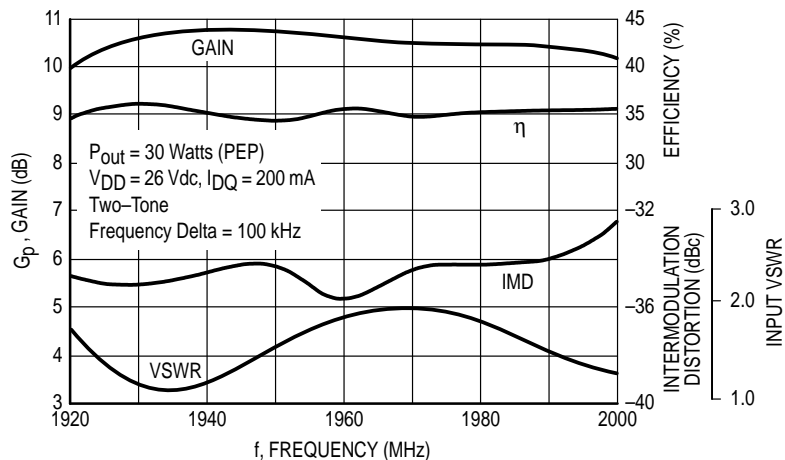
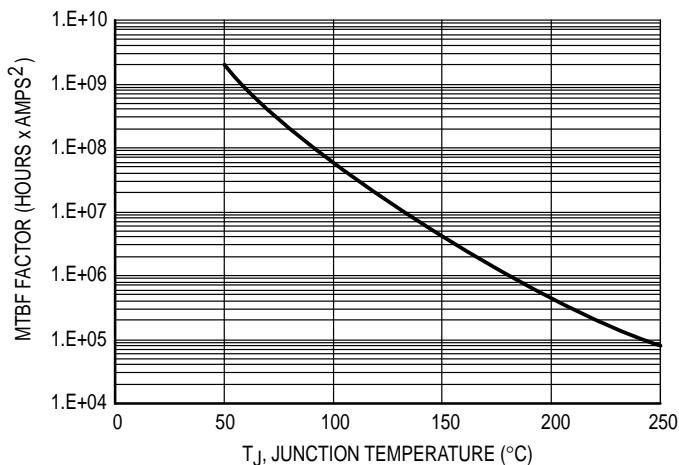
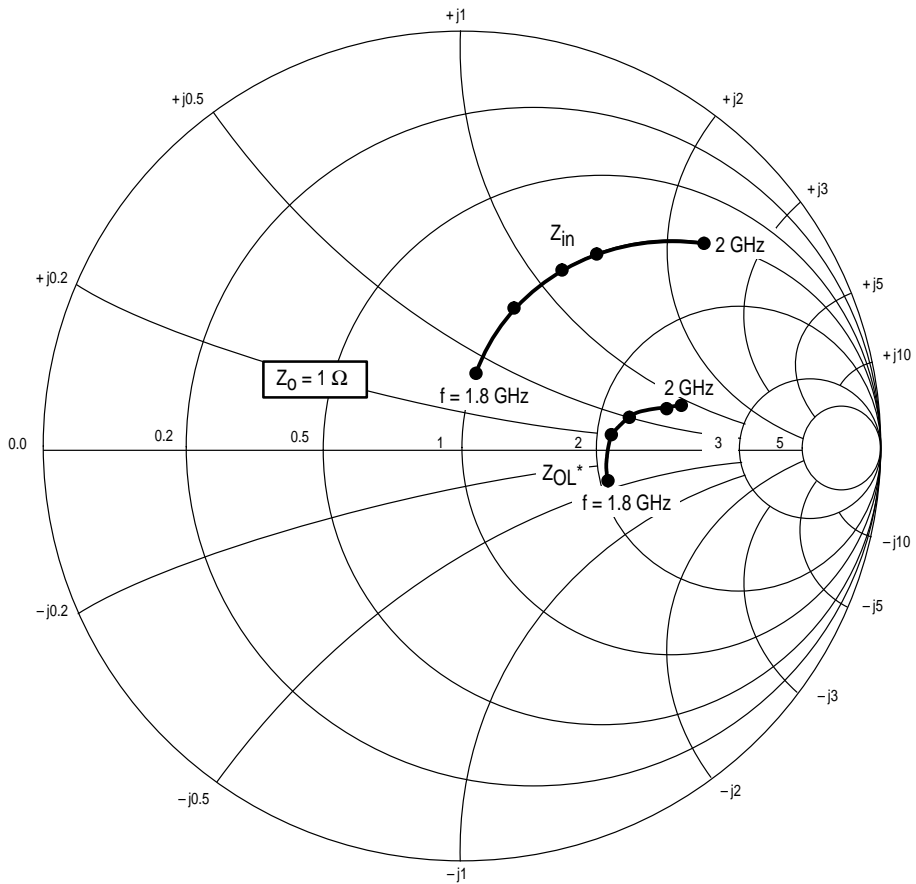

Figure 12. 1.92–2.0 GHz Broadband Circuit Performance



This graph displays calculated MTBF in hours x ampere² drain current. Life tests at elevated temperature have correlated to better than ±10% of the theoretical prediction for metal failure. Divide MTBF factor by I_D^2 for MTBF in a particular application.

Figure 13. MTBF Factor versus Junction Temperature



$V_{CC} = 26 \text{ V}$, $I_{CQ} = 200 \text{ mA}$, $P_{out} = 15 \text{ W}_{avg}$

f MHz	$Z_{in}(1)$ Ω	Z_{OL}^* Ω
1800	$1.0 + j0.4$	$2.1 - j0.4$
1860	$1.0 + j0.8$	$2.2 + j0.2$
1900	$1.0 + j1.1$	$2.3 + j0.5$
1960	$1.0 + j1.4$	$2.5 + j0.9$
2000	$1.0 + j2.3$	$2.6 + j0.92$

$Z_{in}(1)$ = Conjugate of fixture base terminal impedance.

Z_{OL}^* = Conjugate of the optimum load impedance at given output power, voltage, bias current and frequency.

Figure 14. Series Equivalent Input and Output Impedence

Table 1. Common Source S-Parameters at $V_{DS} = 26$ Vdc, $I_D = 1.8$ Adc

f GHz	S ₁₁		S ₂₁		S ₁₂		S ₂₂	
	S ₁₁	∠ φ	S ₂₁	∠ φ	S ₁₂	∠ φ	S ₂₂	∠ φ
1.0	0.902	-170	1.10	28	0.005	60	0.913	-162
1.1	0.934	-167	0.92	26	0.006	82	0.921	-163
1.2	0.948	-167	0.85	24	0.007	89	0.924	-164
1.3	0.957	-169	0.73	21	0.009	94	0.929	-165
1.4	0.959	-169	0.68	19	0.011	94	0.931	-165
1.5	0.960	-170	0.59	17	0.014	94	0.933	-167
1.6	0.958	-172	0.53	14	0.015	92	0.936	-168
1.7	0.958	-172	0.50	13	0.016	93	0.936	-169
1.8	0.956	-174	0.45	10	0.019	92	0.937	-170
1.9	0.954	-175	0.43	8	0.020	90	0.937	-171
2	0.944	-177	0.39	6	0.023	82	0.937	-173
2.1	0.934	-177	0.38	4	0.023	72	0.935	-174
2.2	0.935	-178	0.35	-1	0.013	72	0.932	-176
2.3	0.945	180	0.31	-4	0.016	116	0.925	-179
2.4	0.944	178	0.30	-5	0.023	112	0.930	-179
2.5	0.946	177	0.29	-7	0.024	105	0.935	179
2.6	0.941	174	0.25	-11	0.025	112	0.930	176

NOTES

PACKAGE DIMENSIONS

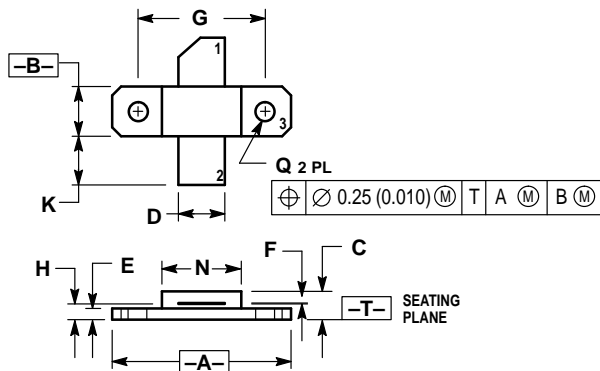

**CASE 360B-01
ISSUE O
(MRF284)**

- NOTES:
 1. DIMENSIONING AND TOLERANCING PER ANSI Y14.5M, 1982.
 2. CONTROLLING DIMENSION: INCH.

DIM	INCHES		MILLIMETERS	
	MIN	MAX	MIN	MAX
A	0.790	0.810	20.07	20.57
B	0.220	0.240	5.59	6.09
C	0.125	0.175	3.18	4.45
D	0.205	0.225	5.21	5.71
E	0.050	0.070	1.27	1.77
F	0.004	0.006	0.11	0.15
G	0.562 BSC		14.27 BSC	
H	0.070	0.090	1.78	2.29
K	0.215	0.255	5.47	6.47
N	0.350	0.370	8.89	9.39
Q	0.120	0.140	3.05	3.55

- STYLE 1:
 PIN 1. DRAIN
 2. GATE
 3. SOURCE

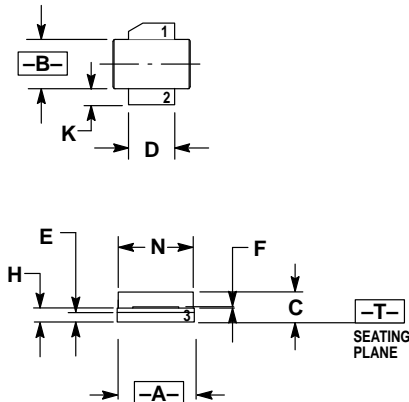

**CASE 360C-03
ISSUE B
(MRF284S)**

- NOTES:
 1. DIMENSIONING AND TOLERANCING PER ANSI Y14.5M, 1982.
 2. CONTROLLING DIMENSION: INCH.

DIM	INCHES		MILLIMETERS	
	MIN	MAX	MIN	MAX
A	0.370	0.390	9.40	9.91
B	0.220	0.240	5.59	6.09
C	0.105	0.155	2.67	3.94
D	0.205	0.225	5.21	5.71
E	0.035	0.045	0.89	1.14
F	0.004	0.006	0.11	0.15
H	0.057	0.067	1.45	1.70
K	0.085	0.115	2.16	2.92
N	0.350	0.370	8.89	9.39

- STYLE 1:
 PIN 1. DRAIN
 2. GATE
 3. SOURCE

Motorola reserves the right to make changes without further notice to any products herein. Motorola makes no warranty, representation or guarantee regarding the suitability of its products for any particular purpose, nor does Motorola assume any liability arising out of the application or use of any product or circuit, and specifically disclaims any and all liability, including without limitation consequential or incidental damages. "Typical" parameters which may be provided in Motorola data sheets and/or specifications can and do vary in different applications and actual performance may vary over time. All operating parameters, including "Typicals" must be validated for each customer application by customer's technical experts. Motorola does not convey any license under its patent rights nor the rights of others. Motorola products are not designed, intended, or authorized for use as components in systems intended for surgical implant into the body, or other applications intended to support or sustain life, or for any other application in which the failure of the Motorola product could create a situation where personal injury or death may occur. Should Buyer purchase or use Motorola products for any such unintended or unauthorized application, Buyer shall indemnify and hold Motorola and its officers, employees, subsidiaries, affiliates, and distributors harmless against all claims, costs, damages, and expenses, and reasonable attorney fees arising out of, directly or indirectly, any claim of personal injury or death associated with such unintended or unauthorized use, even if such claim alleges that Motorola was negligent regarding the design or manufacture of the part. Motorola and  are registered trademarks of Motorola, Inc. Motorola, Inc. is an Equal Opportunity/Affirmative Action Employer.

Mfax is a trademark of Motorola, Inc.

How to reach us:

USA/EUROPE/Locations Not Listed: Motorola Literature Distribution;
P.O. Box 5405, Denver, Colorado 80217. 1-303-675-2140 or 1-800-441-2447

JAPAN: Nippon Motorola Ltd.: SPD, Strategic Planning Office, 4-32-1,
Nishi-Gotanda, Shinagawa-ku, Tokyo 141, Japan. 81-3-5487-8488

Customer Focus Center: 1-800-521-6274

Mfax™: RMFAX0@email.sps.mot.com – TOUCHTONE 1-602-244-6609
Motorola Fax Back System – US & Canada ONLY 1-800-774-1848
– <http://sps.motorola.com/mfax/>

ASIA/PACIFIC: Motorola Semiconductors H.K. Ltd.; 8B Tai Ping Industrial Park,
51 Ting Kok Road, Tai Po, N.T., Hong Kong. 852-26629298

HOME PAGE: <http://motorola.com/sps/>



MOTOROLA

MRF284/D