

LT3 Protection Relays

File 9110

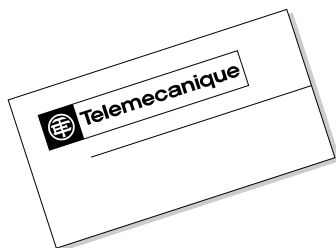

Contents

Application Information	3
Product Selection	4-5
Product Characteristics	6-8
Operation	9
Dimensions and Wiring Diagrams	10



Application Information - Thermistor Protection Relays Provide additional motor protection and should be used to supplement a conventional current sensing overload relay.

LT3S thermistor protection units continuously monitor the temperature of the machines to be protected (motors, generators, etc.) by means of PTC thermistor probes embedded in the machine windings.

If the nominal operating temperature of the probes is reached, they convert the rapid increase in resistance into a switching function which can be used to switch off the machine or signal a fault (see "Thermistor probes" below).

Accidental breaks in the supply circuits of the thermistors are also detected.

Electromagnetic compatibility

Conforming to "Electromagnetic compatibility" directive, draft standard EN 500.82.2

Resistance to electrostatic discharge (conforming to IEC 1000-4-2)

Level 3

Resistance to fast transients (conforming to IEC 1000-4-4)

Level 3

Susceptibility to electromagnetic fields (conforming to IEC 1000-4-3)

Level 3

Surge resistance 1.2/50 - 8/20 (conforming to IEC 1000-4-5)

Level 4

Immunity to microbreaks and voltage drops (IEC 1000-4-11)

Suitable for use with variable speed controllers

Thermistor probes

Thermistor protection relays provide additional motor protection and should be used to supplement a conventional current sensing overload relay.

Range of most commonly used PTC thermistor probes: from 90 to 160 °C, in steps of 10 °C.
Curve $R = f(\theta)$, characteristic of a PTC thermistor probe is defined by standard IEC 34-11.

The choice of PTC thermistor probe to be incorporated in the motor winding depends on the insulation class, the type of motor and the most suitable location for the probe. This choice is usually made by the motor manufacturer or the motor rewinder, who have all the necessary information

Application example

Insulation class of rotating machines conforming to IEC 34-11-2 (S1 duty)	NOT Nominal operating temperature °C	Temperature at which rapid increase in resistance occurs Probes used for	
		Alarm °C	Fault °C
A	100	100	110
B	110	110	120
E	120	120	130
F	140	140	150
H	160	160	170

LT3 Protection Relays Thermistor Protection

Thermistor Protection To Monitor The Temperature of Motor Windings,
Transformer Laminations etc..



LT3SE00M



LT3SA00M



LT3SM00M

Protection Relays (without fault memory).

Units with automatic reset with thermistor short-circuit detection

Voltage		Output contact	Part Number	Weight kg
~ 50/60 Hz	115 VAC	N/C	LT3SE00F	0.220
	230 VAC	N/C	LT3SE00M	0.220
===	24 VDC	N/C	LT3SE00BD	0.220

Units with automatic reset with thermistor short-circuit detection

On front face : fault and voltage signalling indicator.

Voltage		Output contact	Part Number	Weight kg
~ 50/60 Hz	115/230 V	N/C + N/O	LT3SA00M	0.220
	24/48 V	N/C + N/O	LT3SA00ED	0.220
~ 50/60 Hz or ===	24...230 V	2 C/O	LT3SA00MW	0.220

Protection units (with fault memory)

Note: Thermistor protection relays provide additional motor protection and should be used to supplement a conventional current sensing overload relay.

Units with manual reset with thermistor short-circuit detection.

On front face :

- fault and voltage signalling LED,
- Test and Reset button.

Voltage		Output contact	Part Number	Weight kg
~ 50/60 Hz	400 V	N/C + N/O	LT3SM00V	0.220
	24/48 V	N/C + N/O	LT3SM00E	0.220
	115/230 V	N/C + N/O	LT3SM00M	0.220
===	24/48 VAC	N/C + N/O	LT3SM00ED	0.220
~ 50/60 Hz or ===	24...230 VAC	2 C/O	LT3SM00MW	0.220



For use with LT3 Protection Relays



DA1TT●●●

PTC Thermistor Probes

Description	Nominal operating temperature °C	Sold in lots of	Part Number	Weight kg
Integrated triple probes	90	10	DA1TT090	0.010
	110	10	DA1TT110	0.010
	120	10	DA1TT120	0.010
	130	10	DA1TT130	0.010
	140	10	DA1TT140	0.010
	150	10	DA1TT150	0.010
	160	10	DA1TT160	0.010
	170	10	DA1TT170	0.010
Surface probes	60	10	DA1TS060	0.005
	70	10	DA1TS070	0.005
	80	10	DA1TS080	0.005
	90	10	DA1TS090	0.005
	100	10	DA1TS100	0.005



DA1TS●●●

LT3 Protection Relays

Characteristics

Control Circuit Characteristics

Type			LT3SE	LT3SA	LT3SM
Resistance	Tripping	Ω	2700...3100	2700...3100	2700...3100
	Reset	Ω	1500...1650	1500...1650	1500...1650
Maximum number of probes used in series	Probes $\leq 250 \Omega$ to 25°		6	6	6
Voltage at terminals in the thermistor circuit	Normal operation, $R=1500\Omega$	V	< 2.5	< 2.5	< 2.5
	Conforming to IEC 34-11-2, $R=4000\Omega$	V	< 7.5	< 7.5	< 7.5
Short-circuit detection	Operating threshold	Ω	< 20	< 20	< 20
Connection of probes to the LT3	Distance	ft	985	1312	1640
		m	300	400	500 1000
	Minimum size of conductors	AWG	18 AWG	18 AWG	18 AWG
		mm²	.75 mm ² (min) to 2 x 2 mm ² (max)		

Electrical characteristics of the output relay contacts

Contact type	Single voltage or dual voltage		1 N/C	1 N/C + 1 N/O	1 N/C + 1 N/O
	Multi-voltage		–	2 C/O	2 C/O
Rated insulation voltage		V	~ 500		
Maximum operational voltage		V	~250 (~400 V for LT3SM00V)		
Rated impulse withstand voltage	U imp	kV	2.5		
Conventional thermal current		A	5		
Operational power	At 220 V	VA	100 for 0.5 million operating cycles		
Breaking capacity	Cos $\varphi = 0.4 - 24, 48, 127, 240$ V	VA	500	500	500
	$\tau = L/R = 25$ ms	W	50	50	50
Cabling (Box Lug connector) for flexible or solid cable	Without cable end	AWG	up to 2 #18 to #14 AWG		
		mm²	.75 mm ² (min) to 2 x 2 mm ² (max)		
Tightening torque		in lb.	7.0		
		N•m	0.8		

Thermistor probe characteristics

Type			DA1TT●●●	DA1TS●●●
Conforming to standards			IEC 34-11-2 Mark A	
			UL 508/CSA	
Resistance	At 25 °C	Ω	3 x 250 in series	250
Rated operational voltage (Ue)	Per probe	V	$\tau = 2.5$ V max	$\tau = 2.5$ V max
Rated insulation voltage (Ui)		kV	2.5	1
Insulation			Reinforced	Reinforced
Length of connecting cables		Inches	9.84	
	Between probes	mm	250	
	Between probes and motor terminal plate	m	1	



LT3 Protection Relays Characteristics

LT3 Thermistor Protection Relay Characteristics

Type			LT3SE	LT3SA	LT3SM
Reset method			Automatic	Automatic	Manual/Automatic
Fault indication			–	On front face of unit and remote	On front face of unit and remote
Fault test			–	–	By pushbutton on front face of unit
Interchangeability			Label "Mark A" to IEC 34-11-2	Label "Mark A" to IEC 34-11-2	Label "Mark A" to IEC 34-11-2

Environment

Conforming to standards			UL508/CSA IEC 34-11-2 VDE 0660	UL508/CSA IEC 34-11-2 VDE 0660	UL508/CSA IEC 34-11-2 VDE 0660
Approvals			CSA, UL	CSA, UL, PTB, RINA, BV, GL, DNV, LROS	
Degree of protection			IP 20 conforming to IEC 529, VDE 0106		
CE marking			LT3S● protection units have been designed to comply with the basic recommendations of European directives relating to low voltage and EMC. Therefore, LT3S● products bear the European Community CE mark.		
Ambient air temperature around the device	Storage	°F °C	40 to 185 - 40...+ 85		
	Conforming to IEC 68-2-1/68-2-2				
Maximum operating altitude	Without derating	m	1500		
	With derating		Up to 3000 m, the maximum permissible ambient air temperature for operation (60 °C) must be reduced by 5 °C per additional 500 m above 1500 m		
Vibration resistance	Conforming to IEC 68-2-6		2.5 g (2...25 Hz) 1 g (25...150 Hz)		
Shock resistance	Conforming to IEC 68-2-27		5 g (11 ms)		
Operating positions without derating	In relation to normal vertical mounting position		Any		

Power supply circuit characteristics

Rated control circuit voltage (Uc)	~ 50/60 Hz 0.85...1.1 of Nominal Voltage	Single voltage Dual voltage Multi-voltage	V	115 or 230 – –	– 115/230 24...230	400 115/230, 24/48 24...230
	≡ 0.85...1.25 Uc	Single voltage Dual voltage Multi-voltage	V	24 – –	– 24/48 24...230	– 24/48 24...230
Average consumption	Sealed	~	VA	< 2.5	< 2.5	< 2.5
		≡	W	< 1	< 1	< 1



LT3 Protection Relays Characteristics

LT3 Thermistor Protection Relay Characteristics

LT3S protection unit/thermistor probe combination

Guaranteed operating zones : examples with 3 probes type DA1TT●●● (250 Ω to 25 °C) in series, conforming to IEC 34-11-2, mark A.

LT3SE, LT3SA, LT3SM protection units

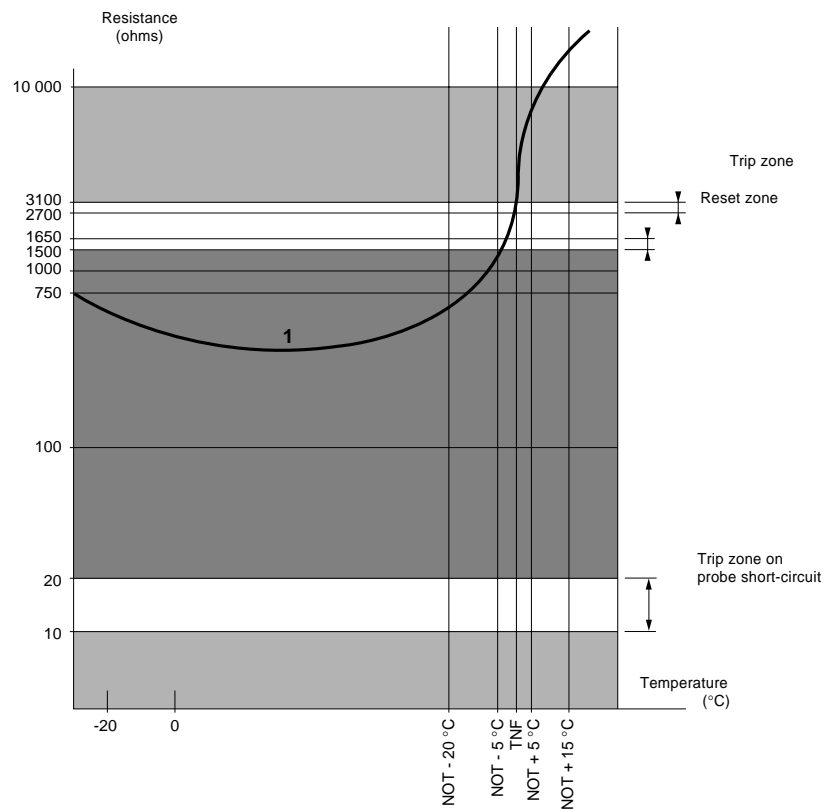

1 3 probes type DA1TT●●● (250 Ω to 25 °C) in series

NOT : Nominal operating temperature

■ Protection unit tripped

■ Protection unit set



LT3 Protection Relays Operation

LT3 Thermistor Protection Relays

LT3SA Protection Relays

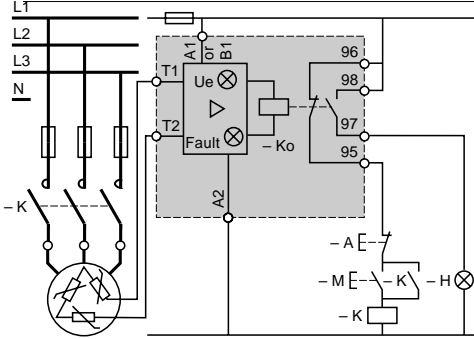

Starting

The LT3SA is normally energized and its internal relay is in the pre-energized position. The motor is started by operating pushbutton M and automatically held in by K (3-wire control circuit).

Thermal fault

The rapid increase in resistance of the PTC probes at the moment their temperature reaches the nominal operating temperature is detected by the LT3SA unit and causes the relay to drop out; indicator H comes on, as does the built-in indicator on unit LT3SA. Contactor K drops out and pressing button M has no effect. Fault indicator will illuminate when the thermistor relay trips.

Reset

As the motor cools it reaches the reset threshold, 2 to 3° C below the nominal operating temperature. The relay resets and the motor can be started by pressing button M.

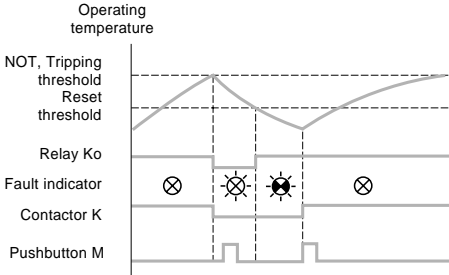

LT3SM Protection Relays

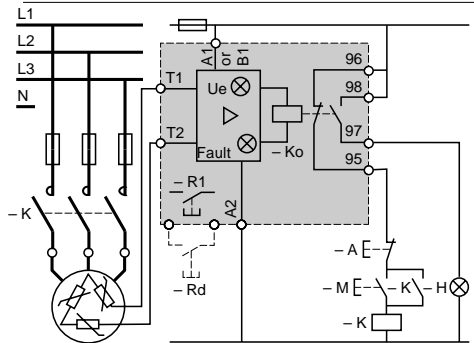

Operation is very similar to that described above, except for the following:

Reset

After tripping on thermal fault and cooling to the reset threshold, the Test/RESET button on the unit (R1) or a remote reset button (Rd) must be pressed to energize the relay.

The fault is therefore memorized, even though the temperature of the probes has dropped to well below the reset threshold.

Signalling circuit

Since the relay has 2 separate contacts, the signalling voltage may be different from the contactor control voltage.

Test

Pressing the Test/RESET button simulates a fault and causes the relay to drop out: the FAULT indicator comes on, as does the remote signalling indicator. The unit is reset by pressing the Test/RESET button again.

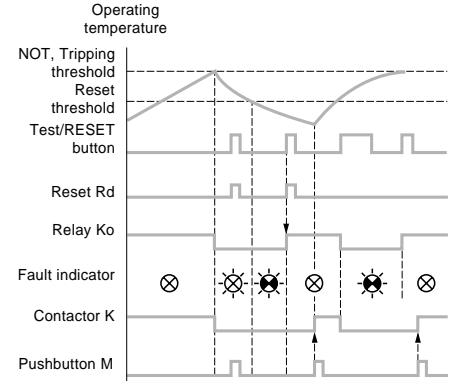

LT3 Protection Relays

Dimensions and Wiring Diagrams

Dimensions

LT3SE, SA, SM

Mounting on rail AM1-DP200

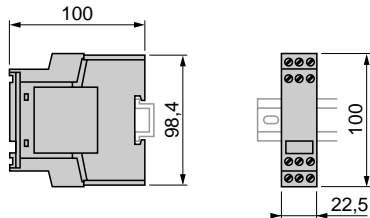

on one □ rail
(with mounting plate RHZ-66)

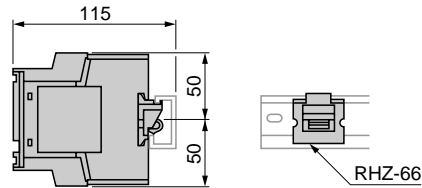

Schemes for "no fault" operation

LT3SE

without fault memory

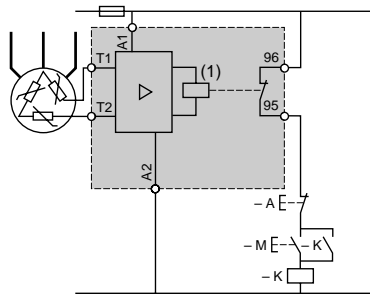

LT3SA dual voltage

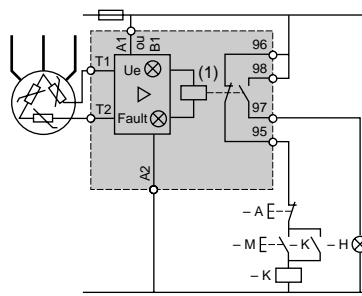

LT3SA multi-voltage

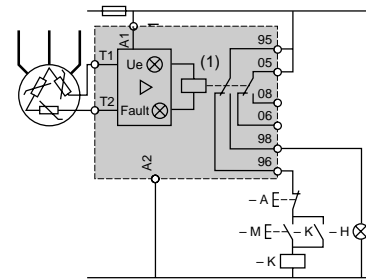

LT3SM dual voltage
and 400 V (without B1)

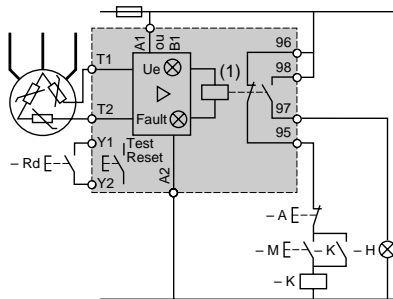

LT3SM multi-voltage

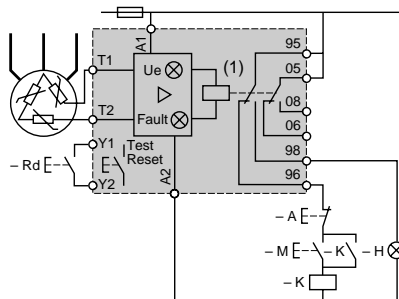

Contacts shown in Energized State





Square D Company
P.O. Box 27446
Raleigh, N.C. 27611, USA
(919) 266-3671

Square D and  are registered trademarks of Square D Company.

Catalog No. 9110CT9701 October 1997 © 1997 Square D All Rights Reserved.